



Wardrobe

1800mm Framed Coloured Glass Sliding Doors

Top Sliding Track x 1 	Bottom Sliding Track x 1 	Back Door Sliding Bracket for Bottom Track x 2 	Back Door Sliding Bracket for Top Track Set x 1 	14mm Wood Screws x 58
		Front Door Sliding Bracket for Bottom Track x 2 	Front Door Sliding Bracket for Top Track Set x 1 	8mm Screws x 72
		Corner Bracket x 4 	Angle Bracket x 4 	28mm Wood Screws x 4
				Door Stopper x 4

STEP 1
CONSTRUCTING THE DOOR

Insert, align and attach the corner brackets into predrilled holes at the top and bottom of the left and right frames with the 8mm screws provided.

Left Frame

Right Frame

Corner Bracket

STEP 2
CONSTRUCTING THE DOOR

Attach the angle brackets in the predrilled holes of the left and right frames with the 8mm screws provided.

Predrilled Holes

Left Frame

Right Frame

STEP 3
CONSTRUCTING THE DOOR

Attach the base frame to the corner brackets on the bottom of the left frame with the 8mm screws provided.

Left Frame

Bottom Frame



CAUTION ! Please ensure all cabinets are screwed into your timber stud wall using a minimum of 8 gauge, 65mm screws. If attaching to concrete, brick, steel or other sub surfaces seek advice from your hardware specialist. Please ensure you follow the installation and safety instructions located on your cabinet assembly instructions carefully.

For further enquiries visit www.flatpax.com.au or call customer service on 1800 666 078 Between 7:00am - 6:30pm E.S.T Mon - Fri

STEP 4
CONSTRUCTING THE DOOR

Place the left frame on the floor, lean against a secure wall and insert bottom door panel into channels

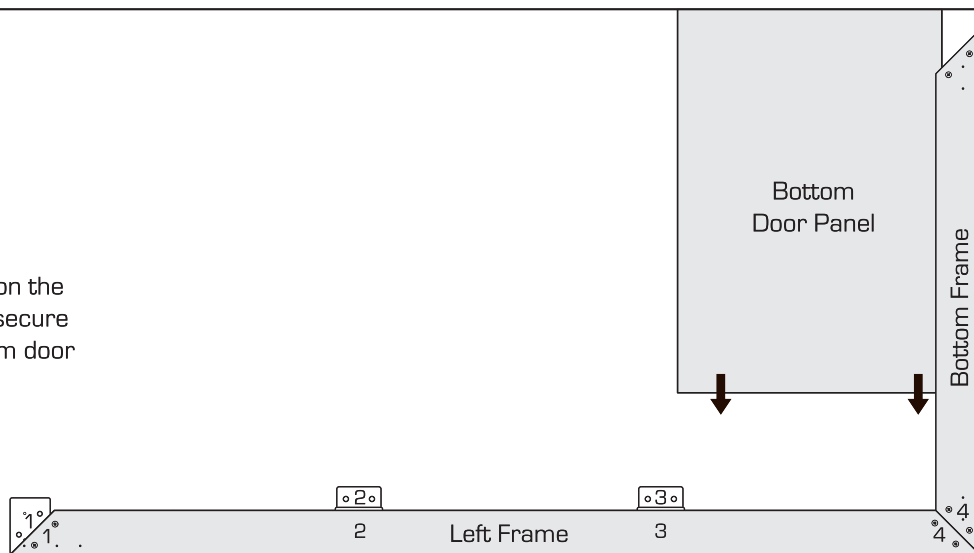

STEP 5
CONSTRUCTING THE DOOR

Attach the first (middle frame) on the angle bracket with the 8mm screws provided to hold the glass. Then insert the middle door panel into the channels.

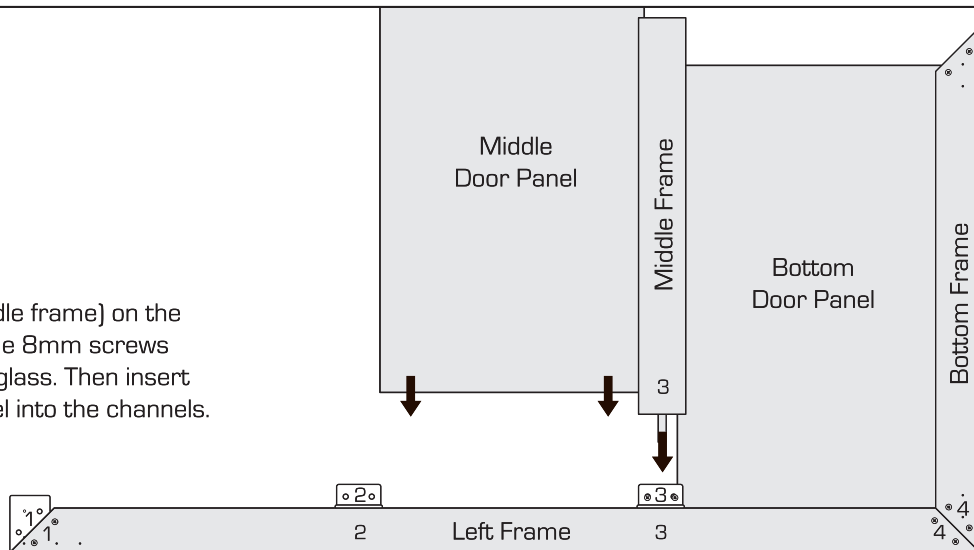

STEP 6
CONSTRUCTING THE DOOR

Attach the next (middle frame) on the angle bracket with the 8mm screws provided.

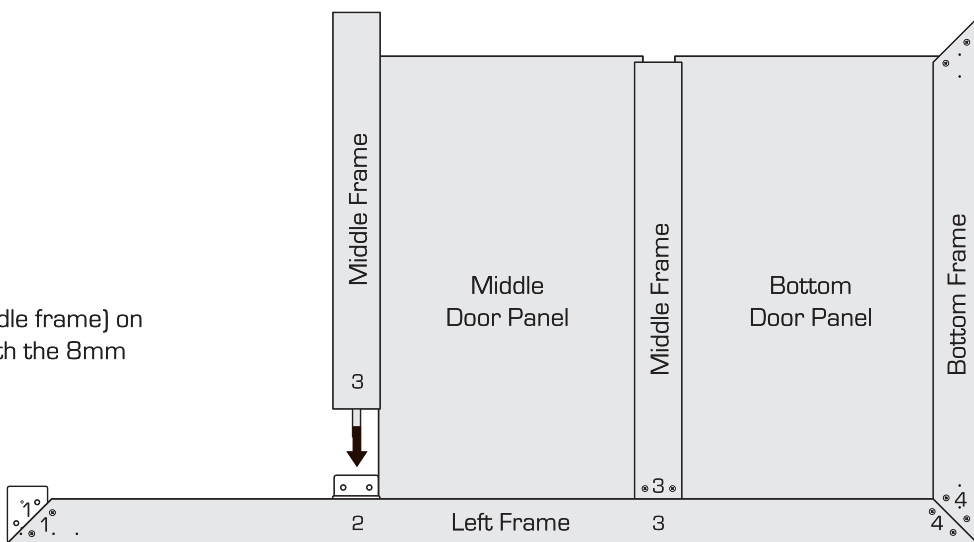

CAUTION ! Please ensure all cabinets are screwed into your timber stud wall using a minimum of 8 gauge, 65mm screws. If attaching to concrete, brick, steel or other sub surfaces seek advice from your hardware specialist. Please ensure you follow the installation and safety instructions located on your cabinet assembly instructions carefully.

For further enquiries visit www.flatpax.com.au or call customer service on 1800 666 078 Between 7:00am - 6:30pm E.S.T Mon - Fri

STEP 7
CONSTRUCTING
THE DOOR

Insert the top door panel into the channels provided.

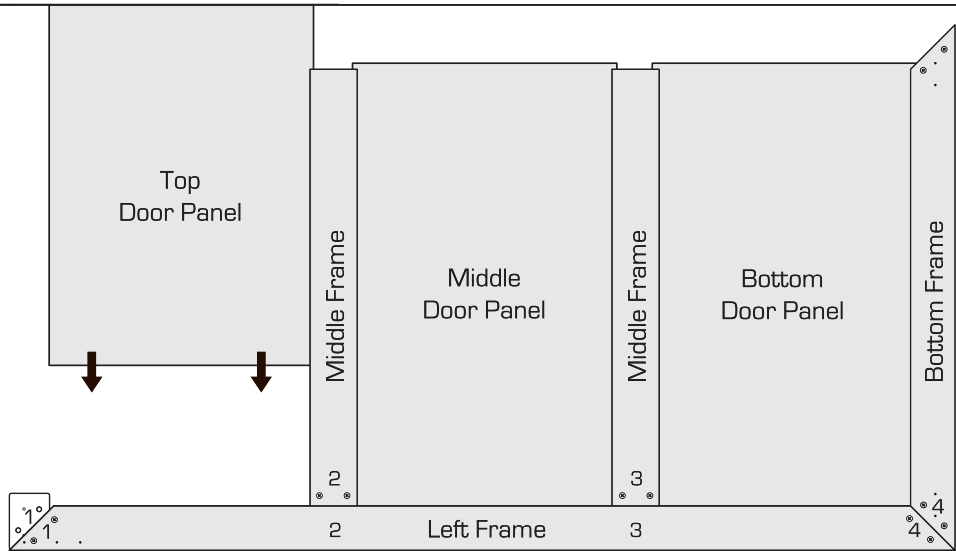

STEP 8
CONSTRUCTING
THE DOOR

Attach the top frame through the corner brackets with the 8mm screws provided.

Insert the right frame into position and fix with the 8mm screws provided.

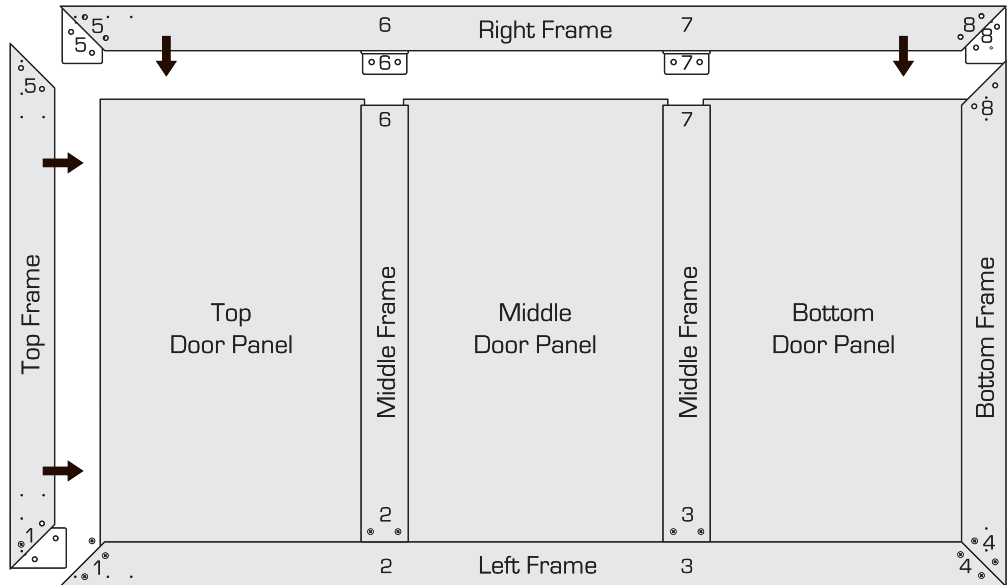

STEP 9
IDENTIFYING TRACK
HARDWARE

The sliding track hardware for the top of the doors consists of two brackets for a "front" door and two brackets for a "back" door.

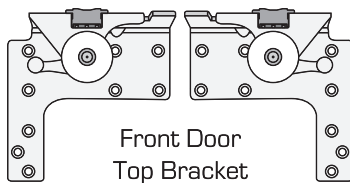

Front Door
Top Bracket

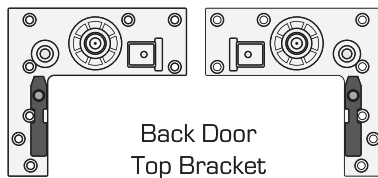

Back Door
Top Bracket

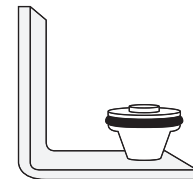

Back Door Bottom Bracket x 2

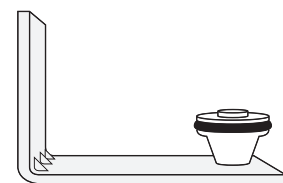

Front Door Bottom Bracket x 2



CAUTION ! Please ensure all cabinets are screwed into your timber stud wall using a minimum of 8 gauge, 65mm screws. If attaching to concrete, brick, steel or other sub surfaces seek advice from your hardware specialist. Please ensure you follow the installation and safety instructions located on your cabinet assembly instructions carefully.

For further enquiries visit www.flatpax.com.au or call customer service on 1800 666 078
Between 7:00am - 6:30pm E.S.T Mon - Fri

STEP 10
ATTACHING THE
TOP BRACKET

Attach the top sliding brackets through the pre-drilled holes using the 8mm screws provided, on both the front and back doors.

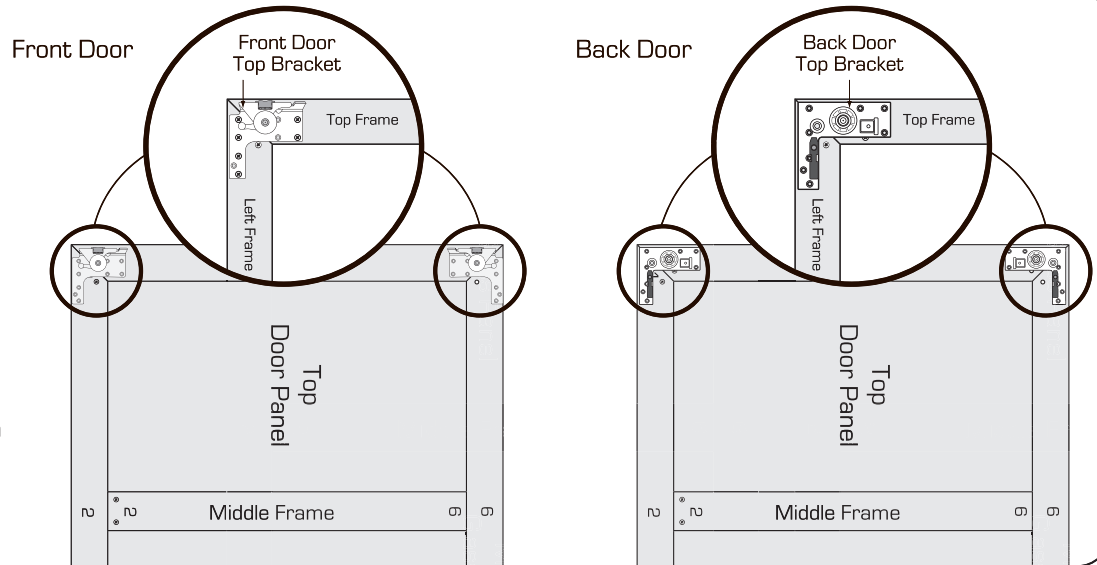

STEP 11
ATTACHING THE
BOTTOM BRACKET

Attach the bottom sliding track brackets through the pre-drilled holes using the 8mm screws provided, on both the front and back doors.

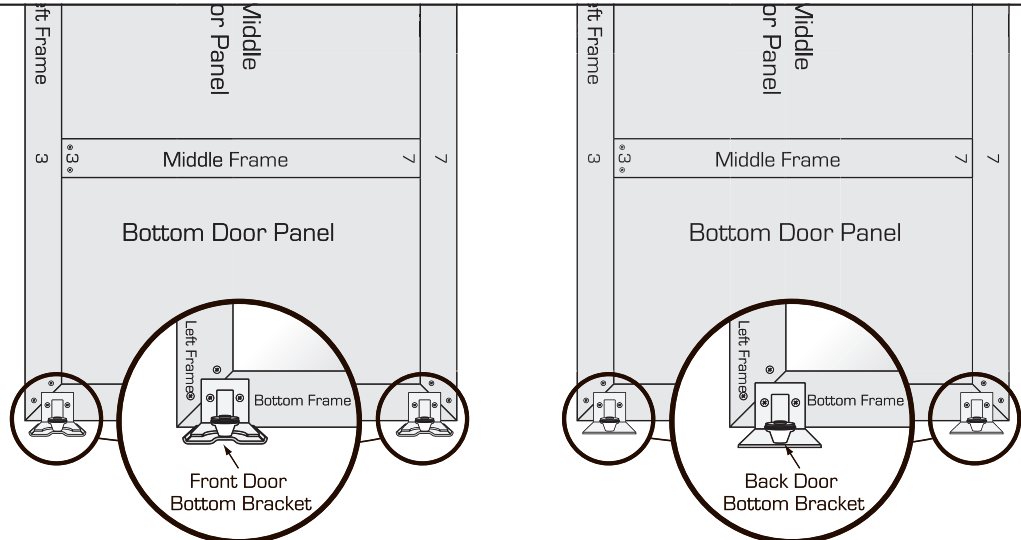

STEP 12
ATTACHING
TOP TRACK

Attach the top sliding track to the top of the cabinets through the pre-drilled holes using the 14mm screws.

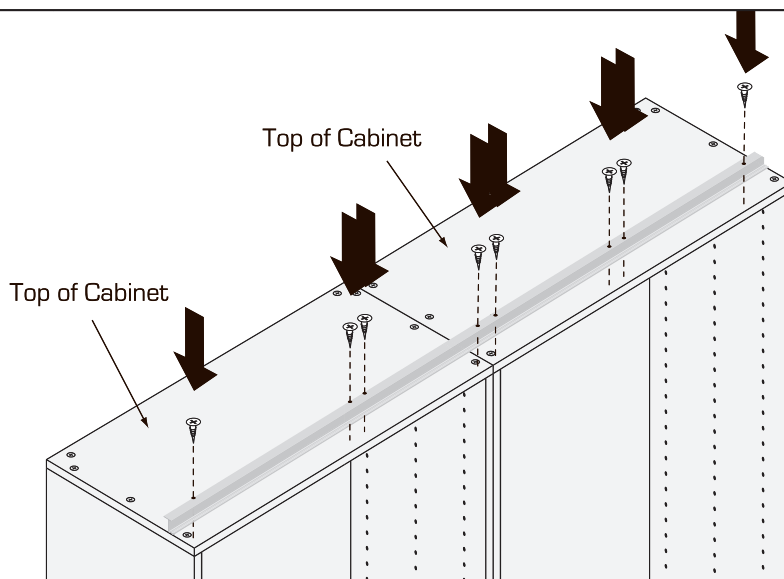

STEP 13
ATTACHING
BOTTOM TRACK

Attach the bottom sliding track to the underside of the cabinet through the door stopper and into the pre-drilled holes using the 14 and 28mm screws provided.

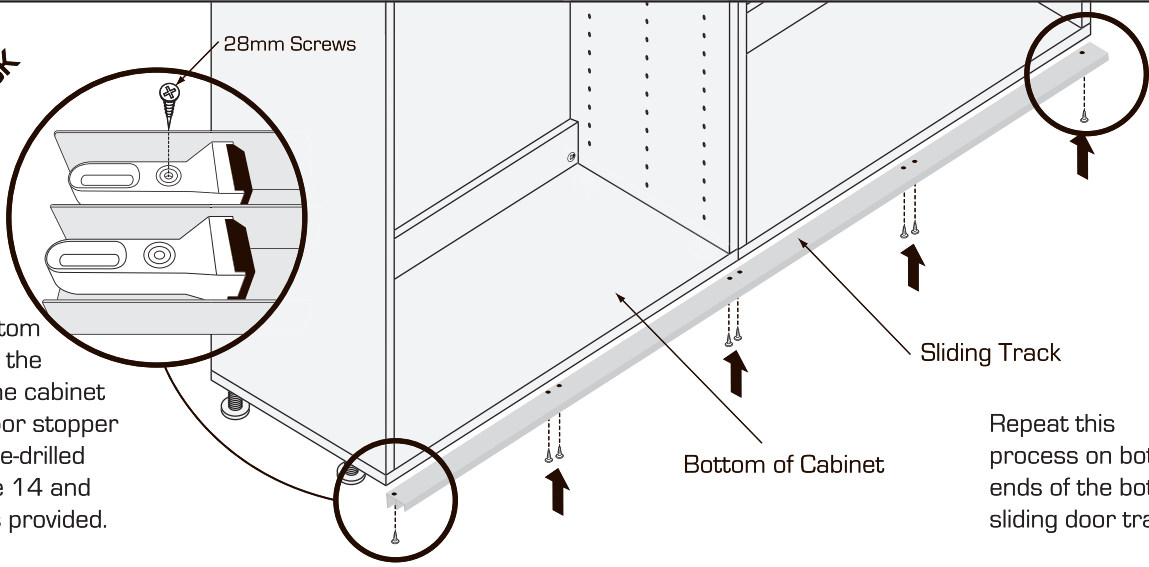

Repeat this process on both ends of the bottom sliding door track.

STEP 14
HANGING
BACK DOOR

Hang the back door first by lifting it up so the wheel at the bottom is inserted into the bottom track and then tilting it forward to place the top wheels on the top track (at the front) and lock into position.

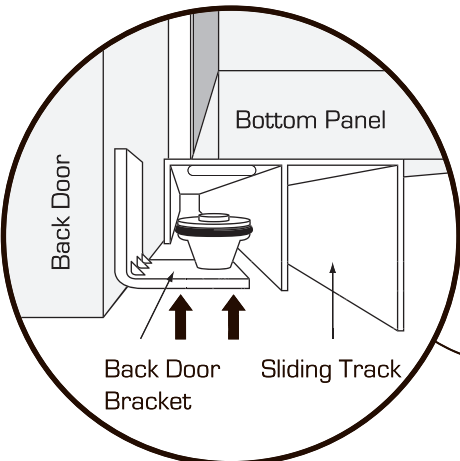
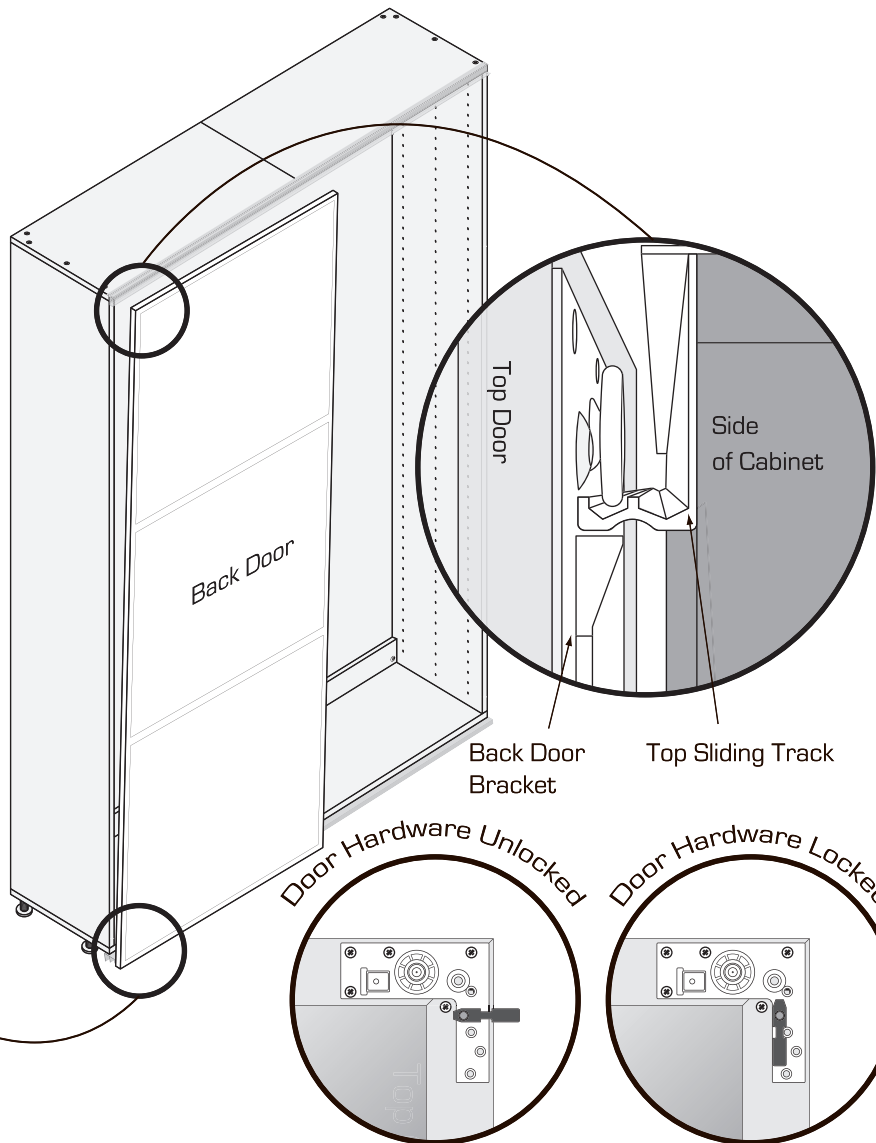

STEP 15
HANGING
FRONT DOOR

Hang the front door as per Step 14. Please ensure back door is pushed all the way to the right, then hang the front door to the left, as to not hit the other door. Position the wheels to the back of the sliding tracks and then lock them in.

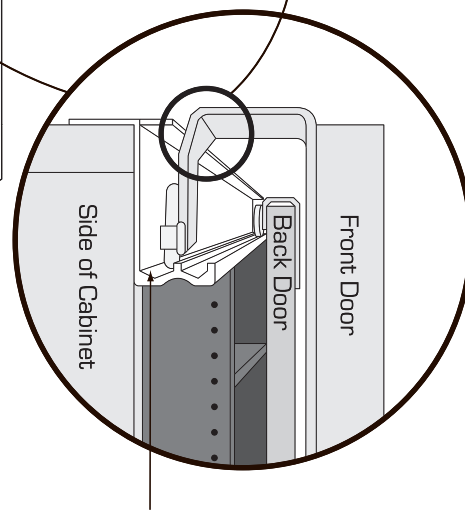
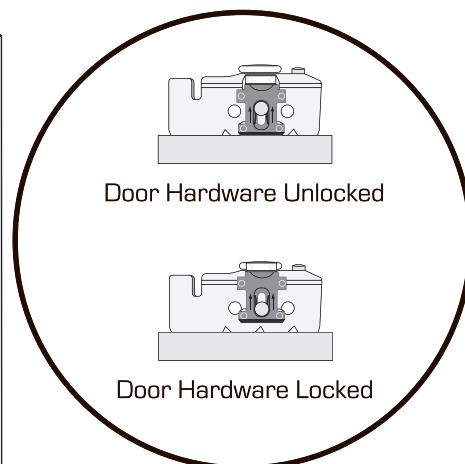
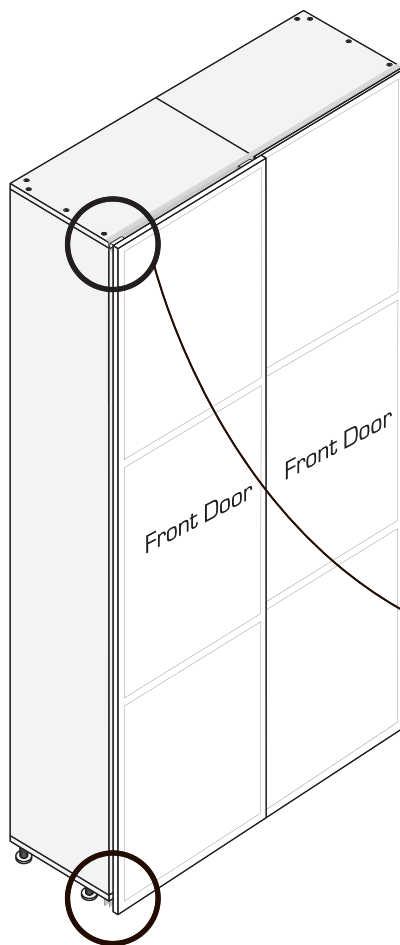
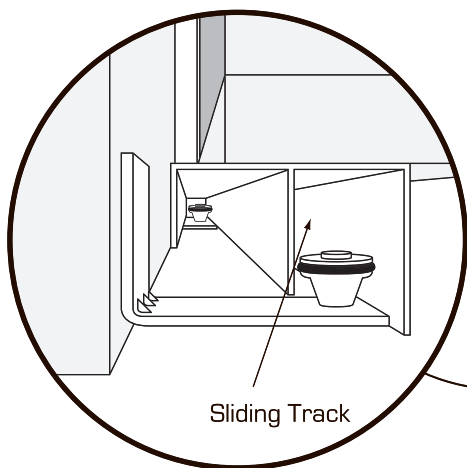

STEP 16
ATTACHING
END CAP

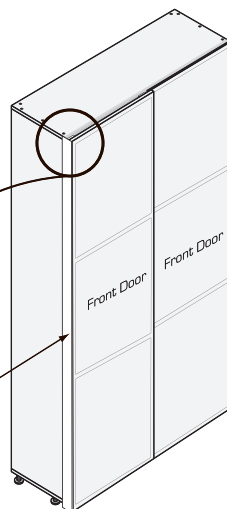
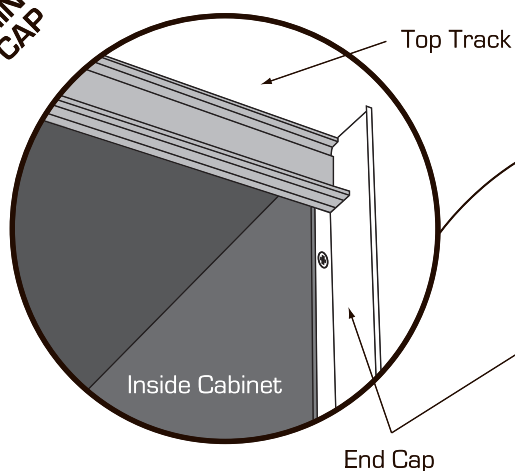

There are two pieces of "End Cap" to be attached to the ends of your wardrobe. Attach these to the front of the cabinets through the pre-drilled holes using the 14mm screws.



CAUTION ! Please ensure all cabinets are screwed into your timber stud wall using a minimum of 8 gauge, 65mm screws. If attaching to concrete, brick, steel or other sub surfaces seek advice from your hardware specialist. Please ensure you follow the installation and safety instructions located on your cabinet assembly instructions carefully.

For further enquiries visit www.flatpax.com.au or call customer service on 1800 666 078
Between 7:00am - 6:30pm E.S.T Mon - Fri